

★★★★ FOUR STAR LAMPS VERSION C-3 ★★★★★



Add: CN6 Far East Industrial Park, Yuyao, Zhejiang, P.R.China
 Tel: 0086-574-62760092 62760098 62760099
 Fax: 0086-574-62760097
 E-Mail: Jane@fourstarlamps.com Janefsl@163.com
 Alice@fourstarlamps.com Alice.3@163.com
 Http: //www.chinalamp.com
 Http: //www.fourstarlamps.com

 **FOUR STAR LAMPS**
 余姚市四星灯具有限公司
 YUYAO FOUR STAR LAMPS CO.,LTD.

Multi Window

Patent 专利产品

Product feature:

- × Die Cast Aluminium Body
- × UV Resistant Powder Coating
- × Glass diffuser
- × Brass or Stainless Steel Fasten Parts

220V~240V / AC 50Hz

MAX 100W

MAX 40W

E27



145101



145107

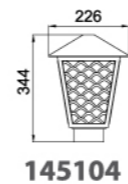

145104

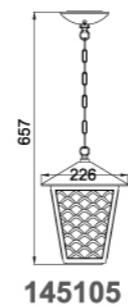

145105

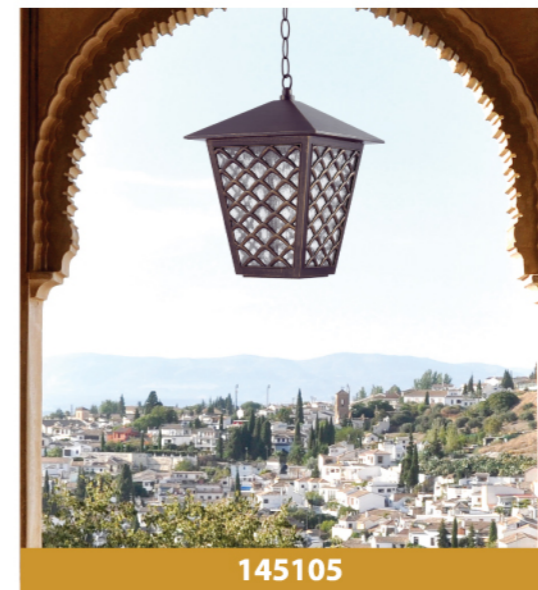

145105



145104

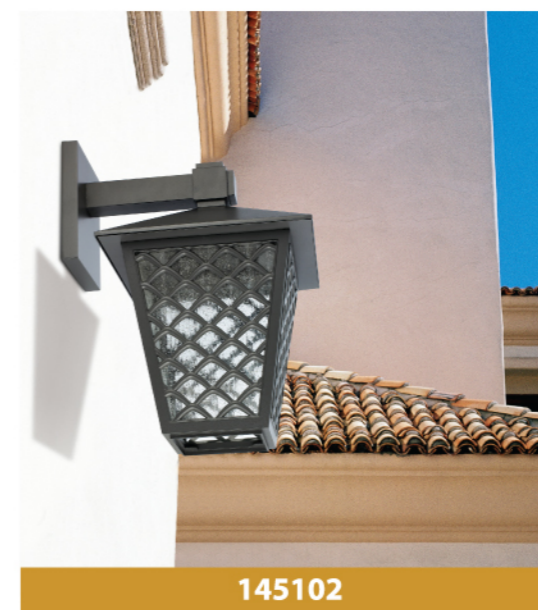

145102



145126

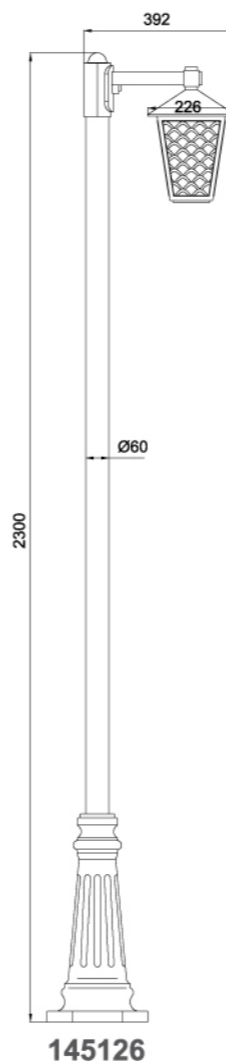

145126

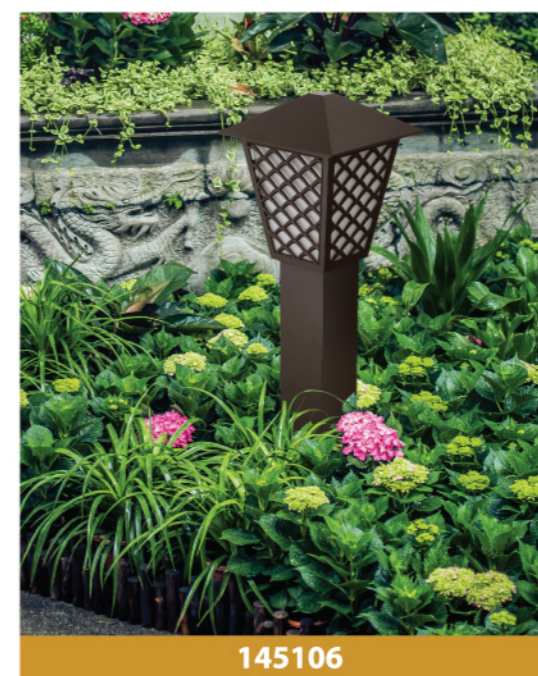

145106

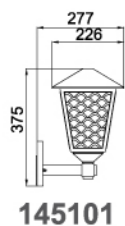

145101

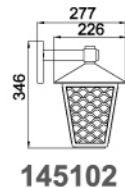

145102

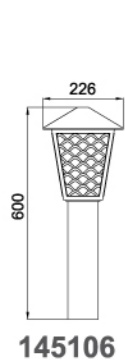

145106

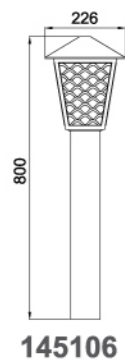

145106

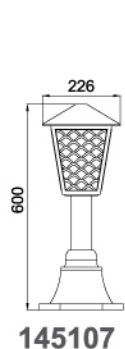

145107

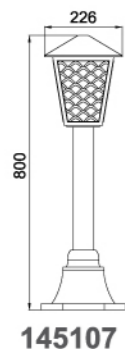

145107

Multi Window

Patent 专利产品

Product feature:

- × Die Cast Aluminium Body
- × UV Resistant Powder Coating
- × Glass diffuser
- × Brass or Stainless Steel Fasten Parts

220V~240V / AC 50Hz

MAX 100W

MAX 40W

E27



145107A



145102A

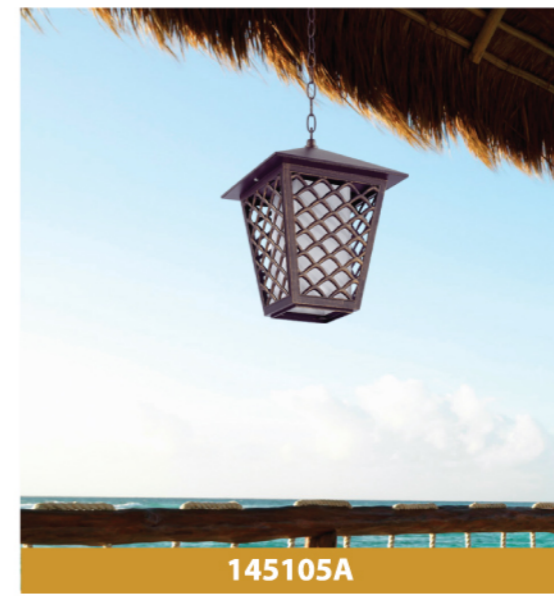
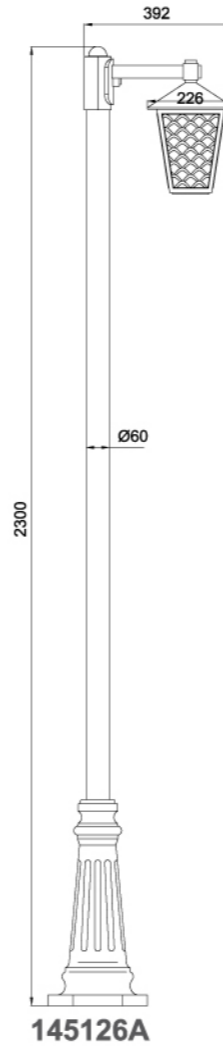
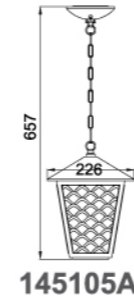
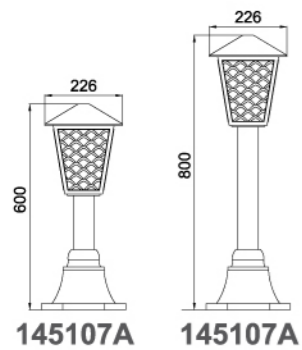
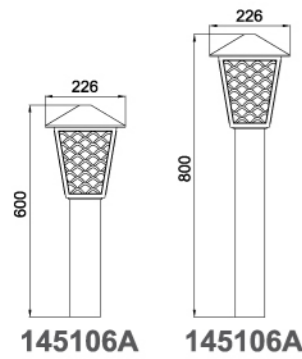
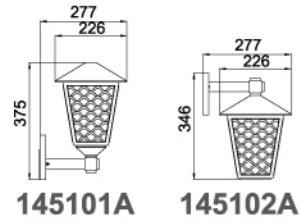

145105A



145104A

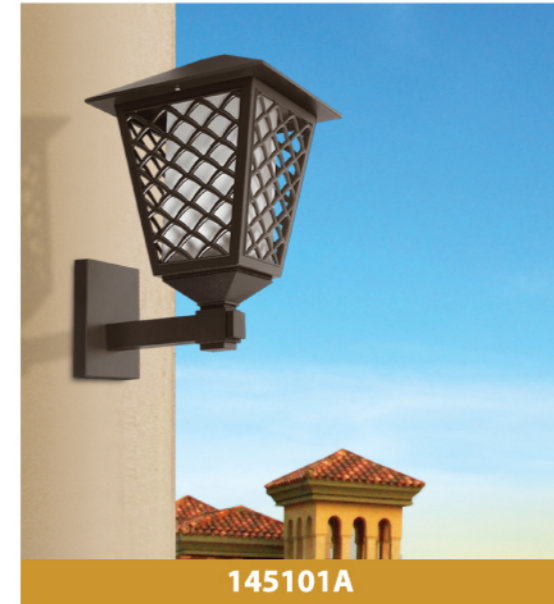

145101A

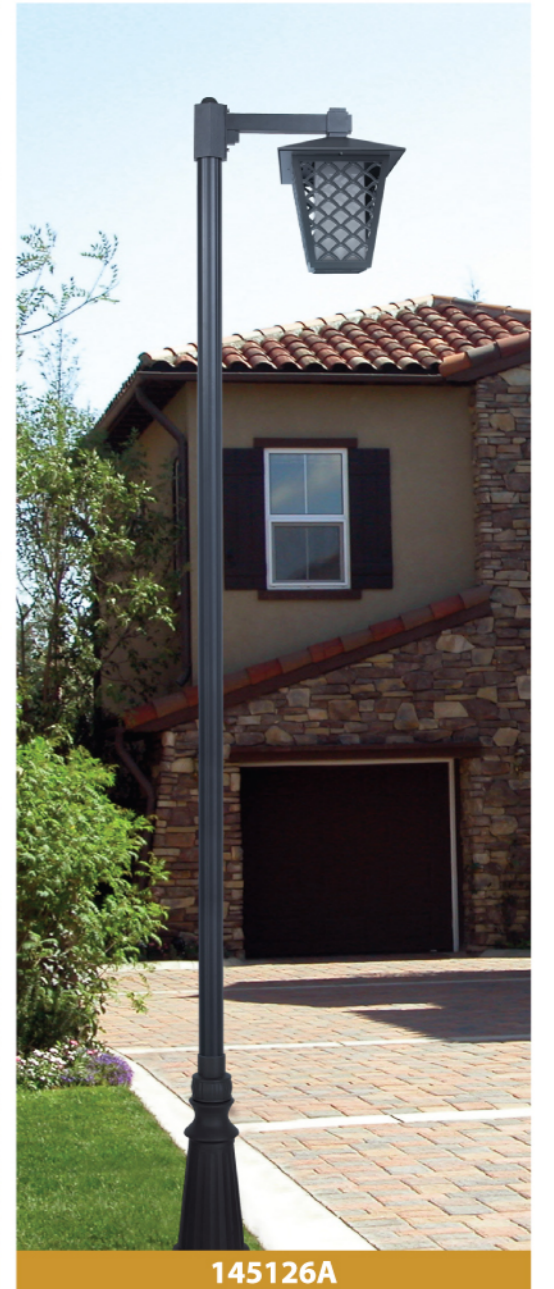

145126A



145106A

Multi Window

Patent 专利产品

Product feature:

- × Die Cast Aluminium Body
- × UV Resistant Powder Coating
- × Glass diffuser
- × Brass or Stainless Steel Fasten Parts

220V~240V / AC 50Hz

MAX 100W

MAX 40W

E27



146102



146106

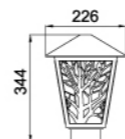

146104

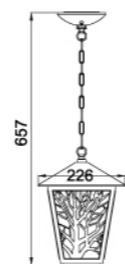

146105



146105



146104



146101



146126

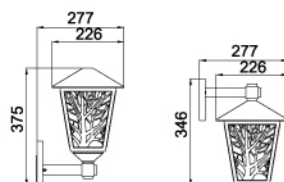

146101

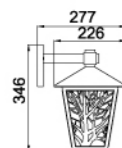

146102

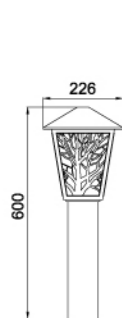

146106

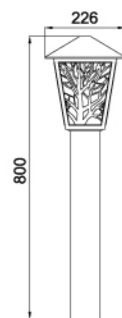

146106

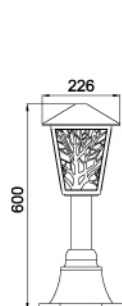

146107

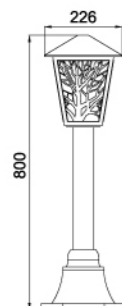

146107

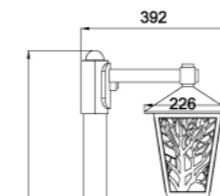

2300

Ø60

146126



146107



146126

Multi Window

Patent 专利产品

Product feature:

- × Die Cast Aluminium Body
- × UV Resistant Powder Coating
- × Glass diffuser
- × Brass or Stainless Steel Fasten Parts

220V~240V / AC 50Hz

MAX 100W

MAX 40W

E27



146106A



146102A

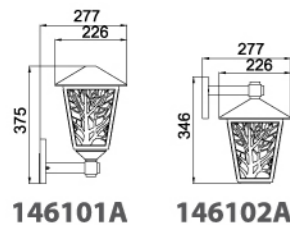

146101A

146102A

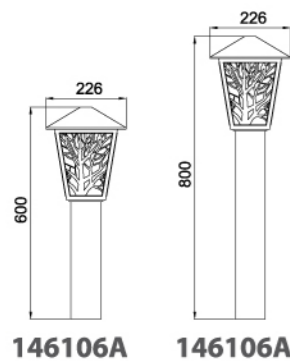

146106A

146106A

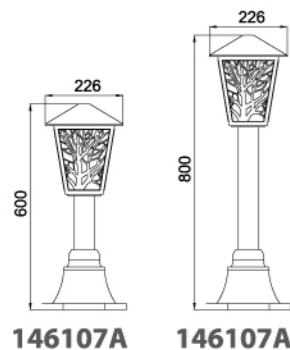

146107A

146107A

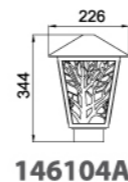

146104A

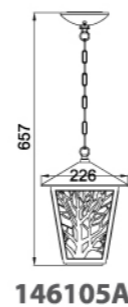

146105A

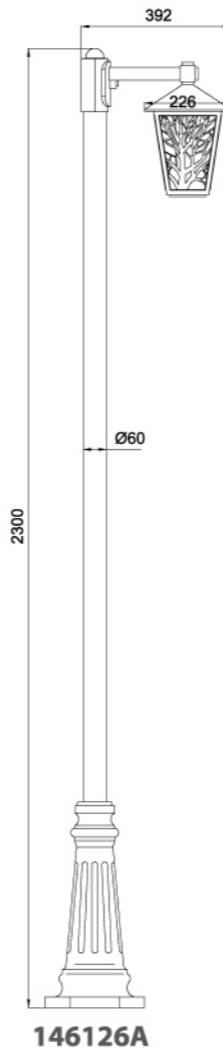

146126A



146105A



146101A



146107A



146104A



146126A

Multi Window

Patent 专利产品

Product feature:

- × Die Cast Aluminium Body
- × UV Resistant Powder Coating
- × Glass diffuser
- × Brass or Stainless Steel Fasten Parts

220V~240V / AC 50Hz

MAX 100W

MAX 40W

E27

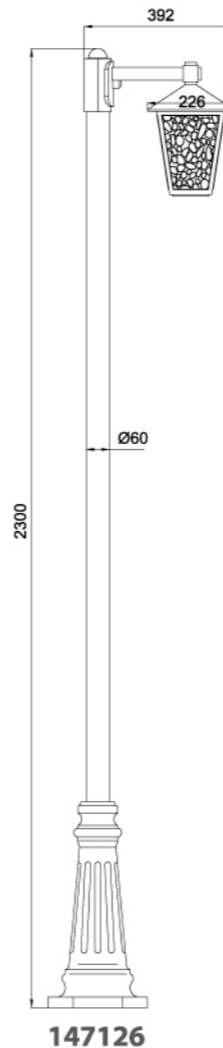
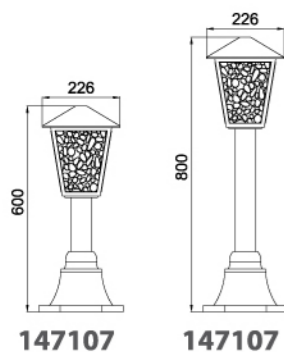
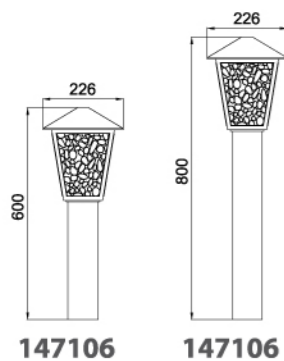
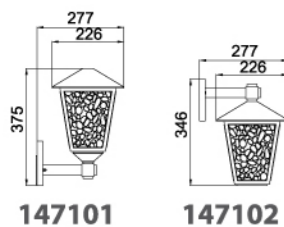
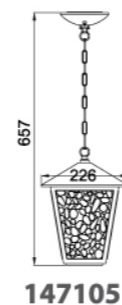
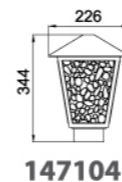

Multi Window

Patent 专利产品

Product feature:

- × Die Cast Aluminium Body
- × UV Resistant Powder Coating
- × Glass diffuser
- × Brass or Stainless Steel Fasten Parts

220V~240V / AC 50Hz

MAX 100W

MAX 40W

E27



147106A



147101A

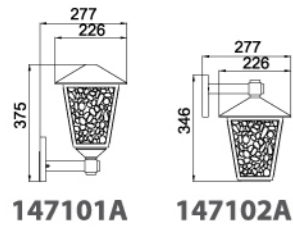

147101A 147102A

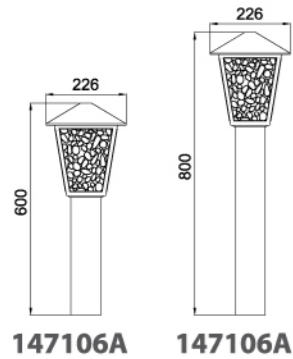

147106A 147106A

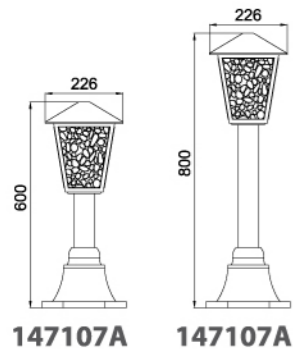

147107A 147107A

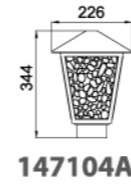

147104A

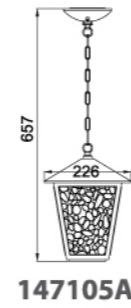

147105A

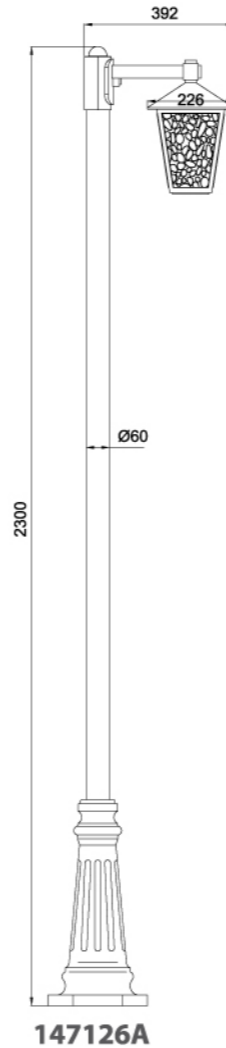

147126A



147105A



147104A

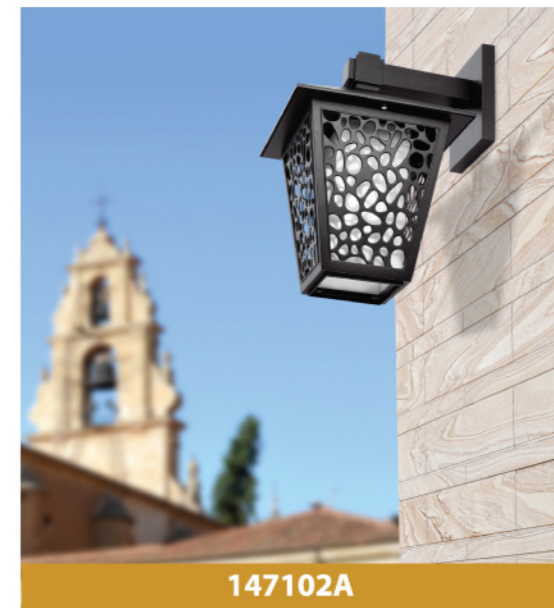

147102A



147126A



147107A

Multi Window

Patent 专利产品

Product feature:

- × Die Cast Aluminium Body
- × UV Resistant Powder Coating
- × Glass diffuser
- × Brass or Stainless Steel Fasten Parts

220V~240V / AC 50Hz

MAX 100W

MAX 40W

E27



148106



148102

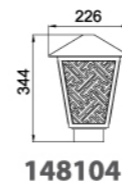

148104

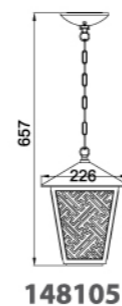

148105

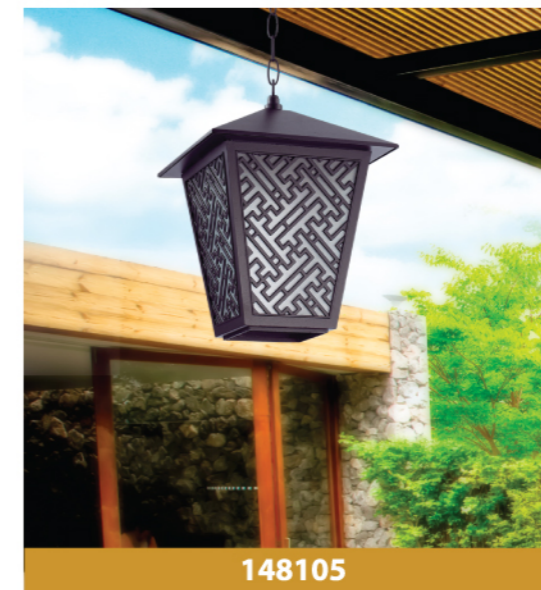

148105



148104

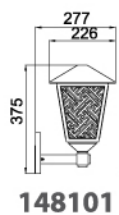

148101

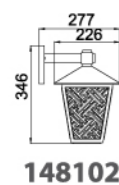

148102

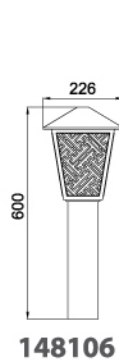

148106

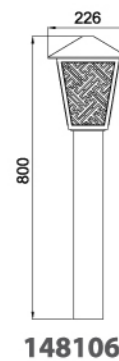

148106

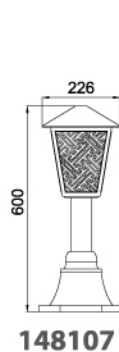

148107

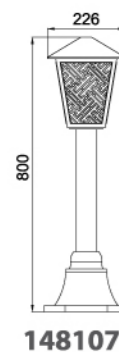

148107

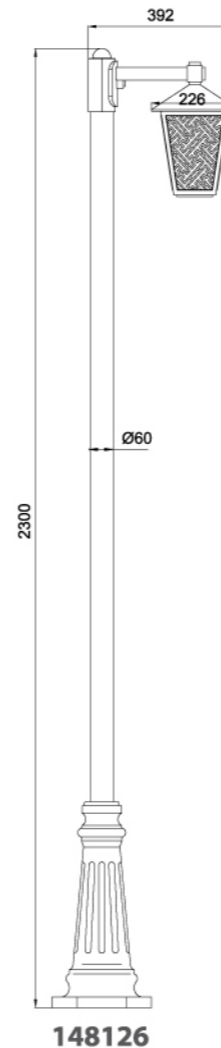

148126



148101



148107



148126

Multi Window

Patent 专利产品

Product feature:

- × Die Cast Aluminium Body
- × UV Resistant Powder Coating
- × Glass diffuser
- × Brass or Stainless Steel Fasten Parts

220V~240V / AC 50Hz

MAX 100W

MAX 40W

E27



148101A



148106A

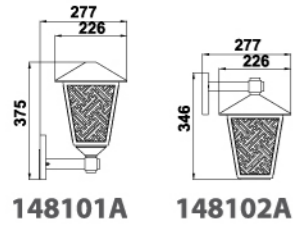

148101A 148102A

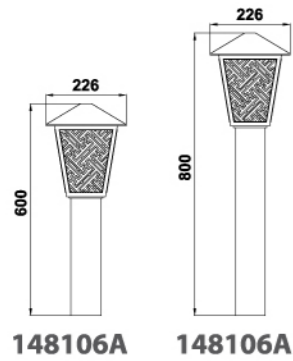

148106A 148106A

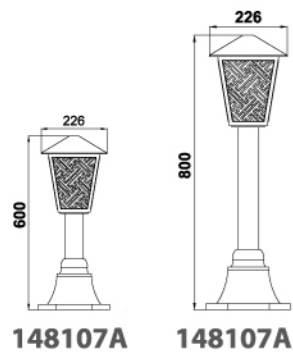

148107A 148107A

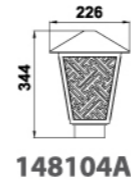

148104A

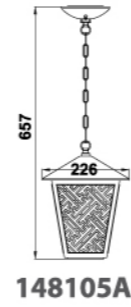

148105A

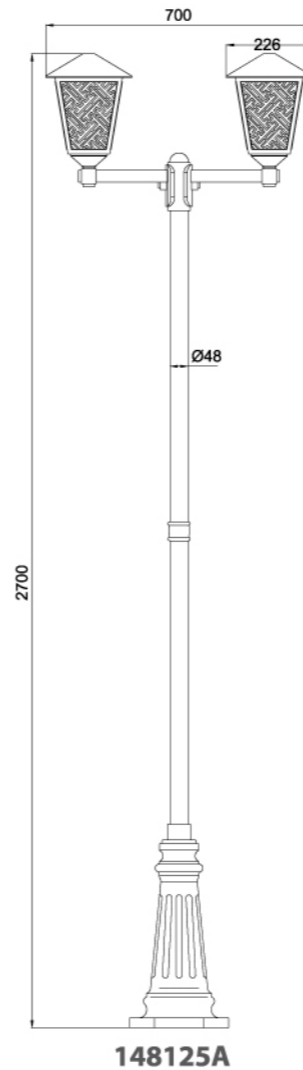

148125A



148105A



148104A



148102A



148107A



148125A

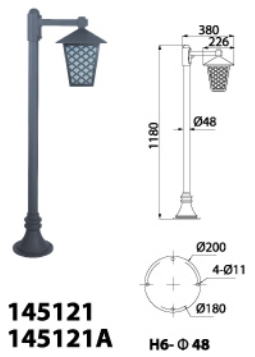

145121
145121A

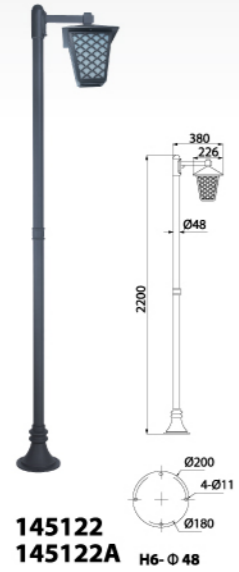

145122
145122A

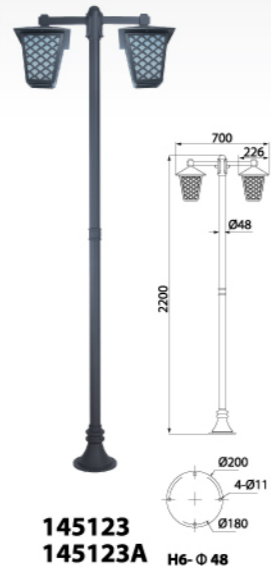

145123
145123A

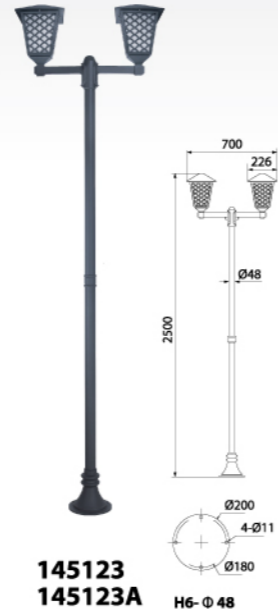

145123
145123A



145124
145124A



146121
146121A

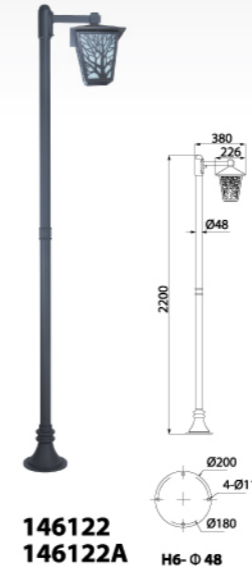

146122
146122A



146123
146123A



146123
146123A



146124
146124A



145125
145125A



145125
145125A



145126
145126A



145127
145127A



145127
145127A



146125
146125A



146125
146125A



146126
146126A



146127
146127A

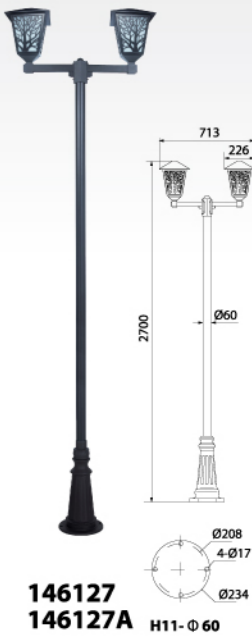

146127
146127A



147121
147121A

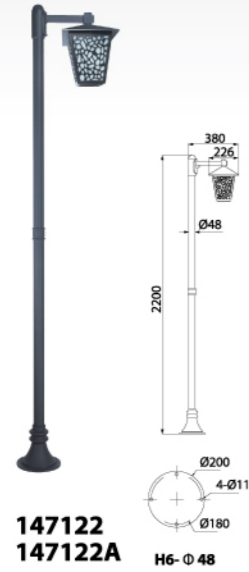

147122
147122A



147123
147123A

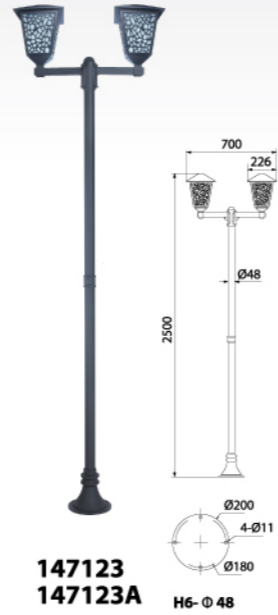

147123
147123A



147124
147124A



148121
148121A



148122
148122A

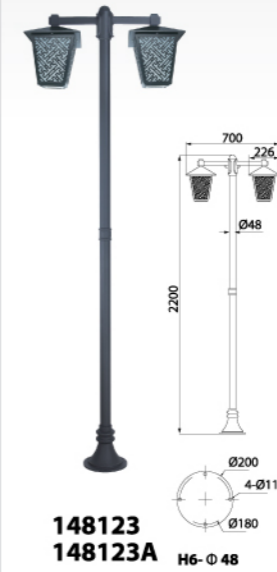

148123
148123A

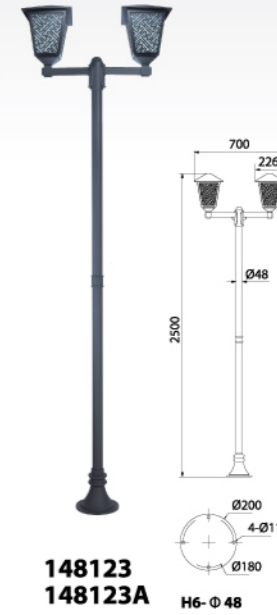

148123
148123A



148124
148124A



147125
147125A



147125
147125A



147126
147126A



147127
147127A

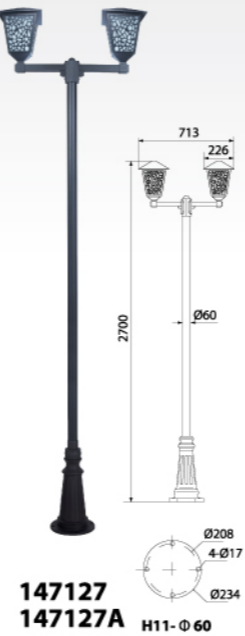

147127
147127A



148125
148125A



148125
148125A

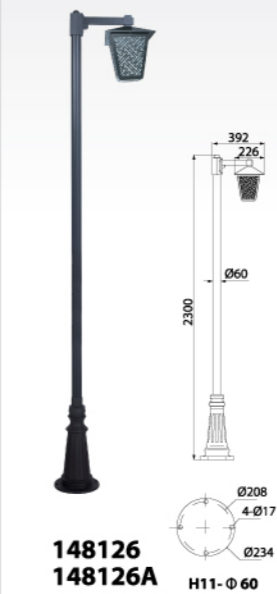

148126
148126A



148127
148127A

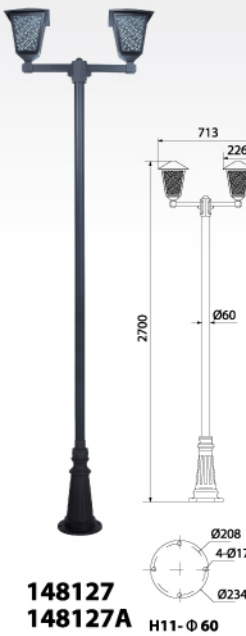

148127
148127A

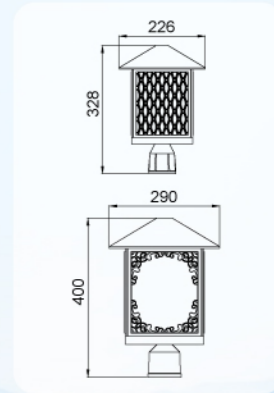
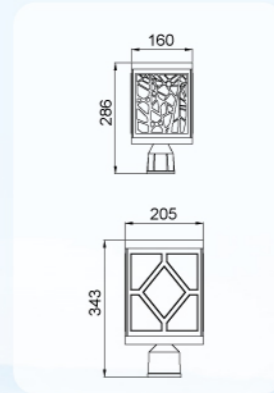
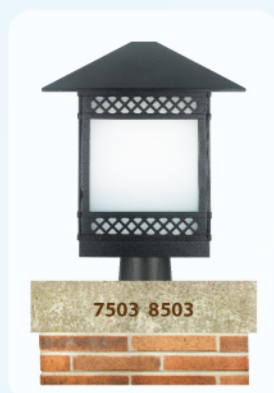

800



141107A



142107A



143107A

800



141107



142107



143107



144107

800



141007A



142007A



143007A

800



141007



142007



143007



144007

800



8507



8607



8707



8807



6707A



6807A

800



6507



6607



6707



6807



8707A



8807A